

KOHLER®

UNINTERRUPTIBLE
POWER



KOHLER EL100XA SERIES

500 - 3000VA

Technical Specification

CONTENTS

CHAPTER 1 – GENERAL DESCRIPTION	2
1.1 INTRODUCTION	2
1.2 FUNCTIONAL DESCRIPTION	3
1.3 MODES OF OPERATION	4
1.3 COMPONENT DESCRIPTION	5
1.3.1 CABINET	5
1.3.2 POWER MODULE	6
1.3.3 FRONT PANEL	6
1.3.3.1 FRONT PANEL MENU DESCRIPTIONS	7
1.3.3.2 AUDIBLE ALARMS	9
1.3.3.3 TEST BUTTON	9
1.3.4 DRY PORT CONTACTS - INCLUDED	10
1.3.5 SNMP CARD – OPTIONAL EXTRA	10
CHAPTER 2 – TECHNICAL SPECIFICATION	11
8.1 GENERAL SPECIFICATIONS	11
8.2 RECTIFIER SPECIFICATIONS	11
8.3 BATTERY SPECIFICATIONS	12
8.4 INVERTER SPECIFICATIONS	12
8.5 BYPASS SPECIFICATIONS	12
8.6 HEAT DISSIPATION (At nominal load and voltage)	13

CHAPTER 1 – GENERAL DESCRIPTION

1.1 INTRODUCTION

The EL100XA is a high performance Emergency Lighting Static Inverter (SI) system, designed to deliver complete emergency lighting protection for a range of applications, in accordance with European BS EN50171 specification.

Key features

High performance, single phase input and single phase output, modular static inverter system ranging from 0.5kVA to 3kVA.

- Microprocessor Controlled
- Automatic restart of load after inverter shutdown
- Smart AVR function (Two buck / boost modes)
- Wide input range 184V~285V
- Pure Sine Wave Output
- High overload capacity (120% continuous)
- Overload and Short Circuit Protection
- Over temperature protection
- Generator compatible & Cold-start capable
- Full function of LCD display with Audible Alarm
- Smart battery management with large charger; wet battery compatible
- Intelligent double stages of charging control
- System and battery test ability
- High battery recharging current
- Battery current-limit
- Deep discharge protection
- Alarm relay contacts
- RS232 communication port
- Remote Monitoring Panel (Optional)
- SNMP Adapter (Optional)
- MODBUS Adapter (Optional)
- AS400 Card (Optional)

Optional features

- Input/output transformer
- Internal maintenance bypass switch
- DC Earth leakage protection
- High IP rating
- Other voltage options

Model Range

	EL1005XA	EL1012XA	EL1030XA
Power Rating Kva/Kw	0.5/ 0.4	1.2 / 1.0	3 / 2.4
Input AC Voltage	220/230/240 (1Ph + N + PE)		

1.2 FUNCTIONAL DESCRIPTION

The EL100XA is a modular Static Inverter (SI) comprising power module, distribution and batteries in one cabinet.

All components are all accessed from the front of the cabinet with all power connections located at the top of the EL100XA cabinet.

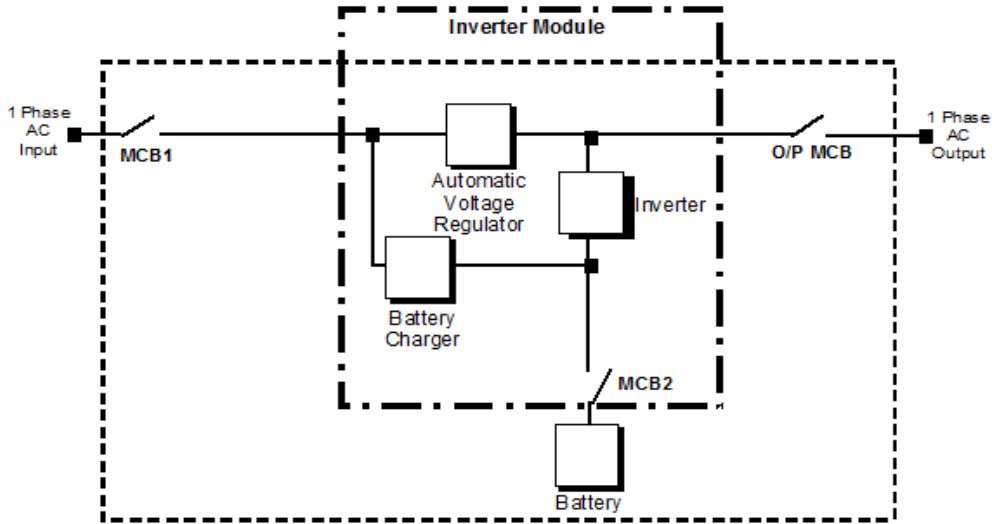

Figure 2.1. Electrical Block Diagram

MCB1	: Mains Input Circuit Breaker.
MCB3-8	: Output Circuit Breaker.
MCB2	: Battery DC Circuit Breaker.

AVR: The first stage of the concept uses a single phase controlled automatic voltage regulator as a form of surge protector. An AVR monitors the voltage constantly to deal with both dips and spikes. This feature includes “Buck” and “Boost” technology to output regulated and controlled voltage at a selectable figure.

CHARGER: In EL100XA Series EL INVERTERS, a controlled charger is used to produce DC voltage for both charging the batteries.

BATTERIES: Batteries are used as reserve DC power supply for the Inverter in case of mains failure. Batteries are connected in series to obtain a DC supply. Batteries are discharged by the inverter during mains failure. The discharged batteries are re-charged by the Rectifier on a constant voltage / current limiting basis, if AC mains power is available.

INVERTER: The Inverter converts the DC BUS voltage supplied by the batteries into a well regulated, fully digital controlled AC voltage with fixed voltage and frequency.

The output of the inverter is used to supply the critical loads connected to the EL INVERTER output.

STATIC TRANSFER SWITCH (STS): This is an electronically controlled transfer switch, which enables the critical load to be connected either to inverter output or to by-pass power source. During normal operation, the load is supplied by the mains output, in case of a mains disturbance or a mains failure the load is automatically transferred to the inverter source.

1.3 MODES OF OPERATION

Changeover mode

When operating in the 'changeover' mode the rectifier is turned on to provide battery charging. The inverter is turned on and operating on standby (off load). The bypass-side of the static switch is turned on to connect the SI OUTPUT to the AC INPUT via the internal bypass line.

If the utility supply fails, the static switch will transfer the SI OUTPUT to the inverter within 10ms. However, as the utility supply is in a failed state the rectifier is inoperative and the inverter will be powered solely from the batteries (see Figure 2.5).

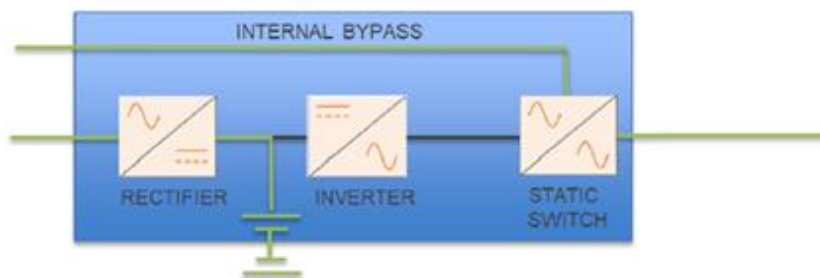

Figure 2.2

On battery operation

If the mains supply fails, the rectifier turns off but the inverter will continue to operate from battery power until the batteries reach their end-of-discharge voltage; at which point the inverter will shut down and disconnect the SI OUTPUT supply.

If the AC INPUT supply is restored before the batteries are fully discharged, the rectifier will turn on automatically to once again power the inverter and recharge the batteries.

The whole process of switching between rectifier and battery power is totally transparent to the emergency luminaires.

1.3 COMPONENT DESCRIPTION

1.3.1 CABINET

The EL100XA cabinet, shown in Figure 2.3, comprises a power module, distribution, batteries and test panel.

All components can be fitted/removed from the front of the cabinet, making side and rear access unnecessary for servicing or repair.

All the AC and DC power cables are connected to terminals located on the top of the cabinet and two gland plates are provided for top cable entry.



Figure 2.3

1.3.2 POWER MODULE

The power module is shelf-mounted.

1.3.3 FRONT PANEL

The front panel of EL-Inverter, consisting of a LCD display, 3 function keys, TEST ON LED, Test Button, allows the complete monitoring of the EL-Inverter status. By using the function keys operator can move on menus.

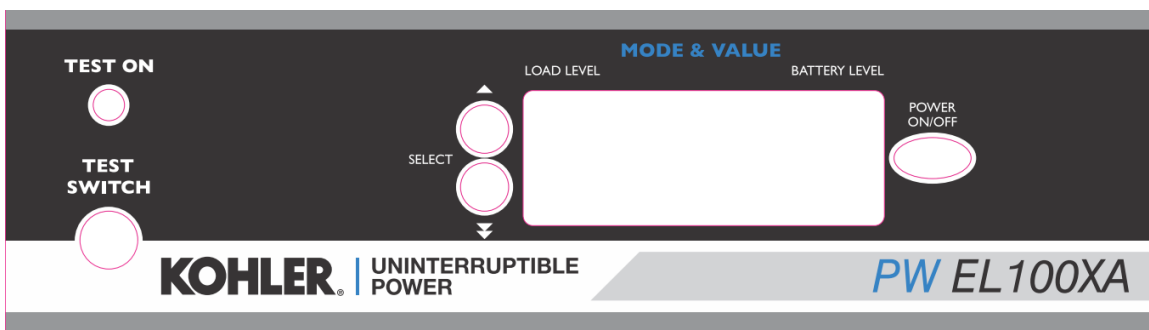

Figure 2.4

LED : If “Test On” lamp is lit maintenance test is active.

There are three function keys on front panel these are MAIN CONTROL ON/OFF BUTTON, UP/DOWN SELECT keys help moving on menus.

NOTE : The main control on/off button will provide test function at normal mode, but will become the alarm-reset function in battery mode.

1.3.3.1 FRONT PANEL MENU DESCRIPTIONS

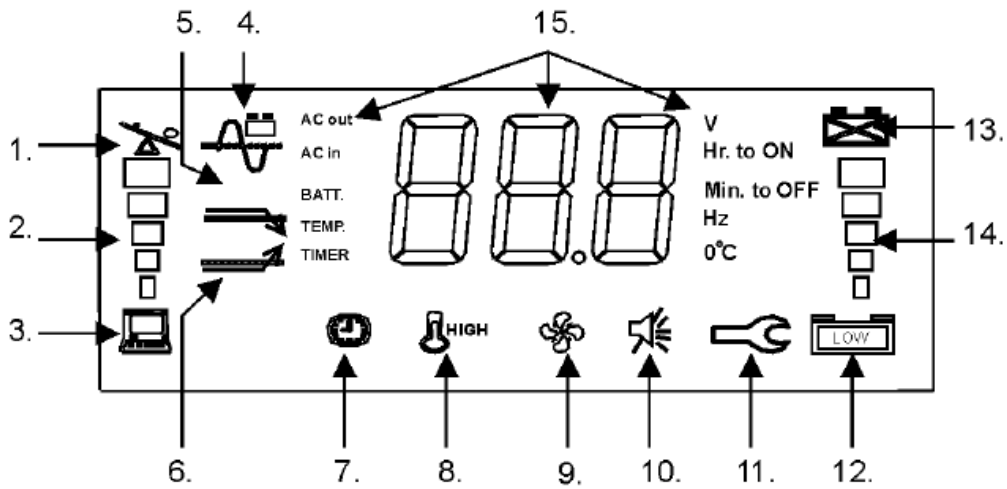
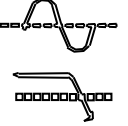
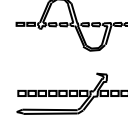





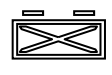



Figure 2.5

No.	Symbol	Indication	Description
1.		Over load	The loading exceeds the rating of Inverter.
2.		Load level	The higher the loading, the more bars will illuminate.
3.		Inverter is loaded	The Inverter is supplying a load.
4.		Normal mode	1) The sine wave symbol will display steadily without battery symbol when Inverter is in the normal mode.
		Battery mode	2) The sine wave symbol and battery symbol will blink when the Inverter is in back-up (inverter) mode.
		Test mode	3) The sine wave symbol will display steadily with blinking battery symbol when the Inverter is in testing mode.

5.		Buck mode	The AVR (Auto Voltage Regulator) is reducing the output voltage of the Inverter (when the input voltage is too high), and the sine wave symbol, as mentioned in item 4, will also display steadily to indicate that the output is in the normal mode.
6.		Boost mode	The AVR is increasing the output voltage of the Inverter (when the input voltage is too low), and the sine wave symbol, as mentioned in item 4, will display to indicate it is in the normal mode
8.	 HIGH	Thermal alarm	The temperature inside the Inverter is over 55°C. If the user does not reduce the load, the temperature will continue to rise and the Inverter will shut down automatically at 60°C.
9.		Fan is in "High speed"	The symbol will display whenever the cooling fan is running (or high speed), and will disappear when it is off (or low speed).
10.		Silence mode	The audible alarm has been silenced. To reset the alarm in Back-up mode, push the control button (not available during low battery level or abnormal condition).
11.		Inverter fault	The Inverter has failed and must be repaired. Contact a qualified service person.
12.		Battery normal	1) In normal operation, this symbol indicates a charged battery.
		Battery low	2) When the battery charge level is low, the word "LOW" will be added to the symbol.
13.		Battery replacement	The battery has failed and must be replaced. The battery is checked each time the Test Function is executed.
14.		Battery voltage level	1) The higher the battery voltage, the more bars will illuminate. 2) When the Inverter is charging the battery, the battery symbol and the level indicator will blink together.

15.	Mode	Value	Description
	AC out	V	AC output voltage.
	AC in	V	AC input voltage.
	AC out	Hz	AC output frequency.
	BATT.	V	DC battery voltage.
	TEMP.	°C	Inverter internal temperature.
<p>Selection Button for mode & value</p> <p>All the operation data will be displayed on LCD screen. By selecting the required mode (upward or downward), the related value will be displayed.</p>			

1.3.3.2 AUDIBLE ALARMS

During a utility failure or fault operation, the EL-Inverter emits a beeping sound for warning. In back-up mode, the alarm can be silenced by pushing the “MAIN CONTROL ON/OFF BUTTON” button. However, the warning of low battery will still sound urging user that load will be lost.

Basic Indication Table:

	STATUS	ALARM
Idle mode	Utility Good	No Beep
	Utility outage	No Beep
	Timer on, (refer to Item 5.5)	No Beep
Normal / Back-up mode	Normal (Utility good)	No Beep
	Back-up (No load)	One beep every 4 sec (alarm can be silenced).
	Back-up (Loaded)	2 beeps every 8 sec. (alarm can be silenced).
	Battery Low	4 beeps per sec (alarm can Not be silenced).
Abnormal Condition	Over load	Continuous alarm (alarm can Not be silenced).
	UPS fault	Every other 2 sec., 32 beeps in 2 sec (alarm can Not be silenced).
	Thermal alarm	Every other 2 sec., 32 beeps in 2 sec (alarm can Not be silenced).

1.3.3.3 TEST BUTTON

If the EL-Inverter is in normal operation it is supplying the load by the incoming utility supply. In the case of a failure in this supply, the output is connected to the static inverter output. This transfer operation is performed internally by the control logic of the Inverter.

The operation of the EL-Inverter can be controlled externally; the unit can be forced to supply the output by the Inverter and batteries. This can be achieved by pressing the TEST Button or opening the external test loop.

Note: When the equipment is switched into the Test mode, the red “TEST ON” LED will be lit.

The TEST Button or the external test loop can be used for testing the machine’s operation and performance; it can also be used to maintain the EL-Inverter’s loads.

WARNING: When the TEST Button or the external test loop has been used, it is important that it is switched off so the EL-Inverter can return to a standby operation and the batteries are recharged.

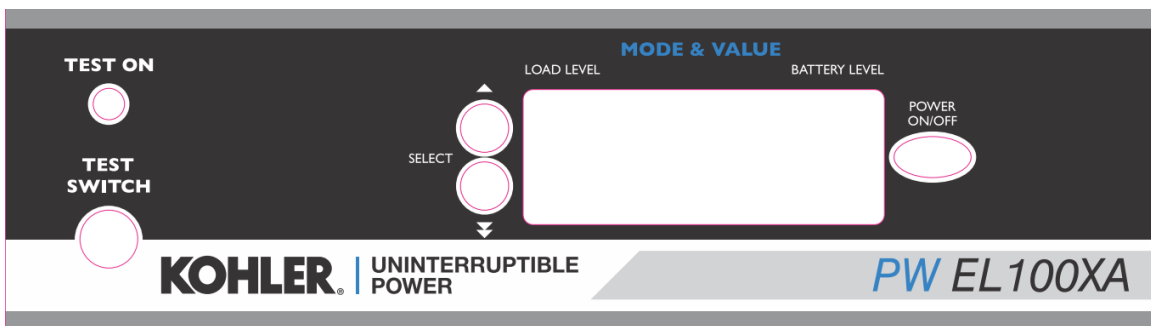

1.3.4 DRY PORT CONTACTS - INCLUDED

The EL100XA provides three hard-wired ‘system status’ outputs that can be used to drive remote signalling and/or monitoring facilities. These output are switched by volt-free relay contacts and are normally open (closed on activation). The contacts are rated for 110VAC (0.5A) or 24VDC.

As shown in Figure 7.2, the four switched alarm outputs are:

- Mains Failure
- Common alarm
- Battery voltage low
- Battery test active

Connections to these terminals are via the 5 provided Din-Rail terminals

DRY PORTS					EXT TEST	
T ACTIVE	COM	M FAIL	C ALARM	LOW. B	LINK 1A	LINK 1B

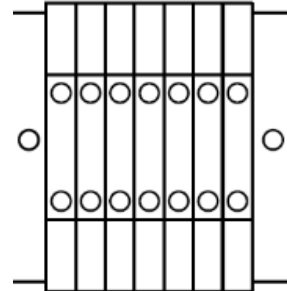

1.3.5 SNMP CARD – OPTIONAL EXTRA

Simple Network Management Protocol (SNMP) is a world-wide, standardised communication protocol that can be used to monitor any network-connected device via a simple control language and display the results in an application running within a standard web browser.

An SNMP card is factory fitted option, designed to house a Modem/Ethernet SNMP adapter card, is located on top of the power module if fitted.

The SNMP adapter card contains an RJ-45 Ethernet connector which allows the EL100XA to be connected to a network using a standard CAT-5 network cable. Once connected, the system management software agent that is preinstalled in the SNMP adapter monitors the EL100XA operation and outputs its data in SNMP format to the connected network.

The communication exchanged between the EL100XA and network enables event/alarm emails, server shut down (with optional licenses) and other tasks to be performed. It can also be integrated with BMS software over a local area network (LAN) for SNMP or Modbus information over IP.

The SNMP adaptor requires a PC with terminal connections, and for normal operation at least one Ethernet connection.

CHAPTER 2 – GENERAL DESCRIPTION

2.1 GENERAL SPECIFICATIONS

Model	EL1005XA	EL1012XA	EL1030XA
Nominal Output Rating (Cos ϕ : 0,8) kVA	0.5kVA	1.25kVA	3kVA
Nominal Output Rating (Cos ϕ : 1) W	400 Watts	1000 Watts	2400 Watts
Efficiency (Load Dependant)	Upto 83% Inverter Mode / Upto 98% Changeover Mode		Upto 86% Inverter Mode / Upto 98% Changeover Mode
Operating Temperature (Ambient)	0-40 °C		
Altitude	<1000 meters (Above Sea level)		
Ventilation	Forced		
Relative Humidity	< 90%		
Protection Degree	IP 20		
Standards	EN 62040-1, EN 62040-2, EN 61000-2-2, EN 61000-3-2, EN 61000-4-2 EN 61000-4-3, EN 61000-4-4, EN 61000-4-5, EN 61000-4-6, EN 61000-4-8 EN 50171		
Transport	Packaged and On Pallet		

2.2 RECTIFIER SPECIFICATIONS

Model	EL1005XA	EL1012XA	EL1030XA
Nominal Input Voltage	230 VAC 1 phase + N		
Max Input current (A) per phase @100% resistive load, No charge current.	2.3A	5.2A	12.6A
Max Input current (A) per phase @100% resistive load, Full charge current.	6A	9A	24.6A
Input MCB Fitted to Cabinet	Type C 10A	Type C 16A	Type C 25A
Input Frequency Range	47 – 55Hz		
Input Power Factor	>0.99		
Input Voltage range	140 – 310 Vac		
Input THDi	<5%		
Input Protection	Fuses, Voltage & Frequency tolerance, Input power limit,		

2.3 BATTERY SPECIFICATIONS

Model	EL1005XA	EL1012XA	EL1030XA
Battery Type	Sealed Lead Acid - maintenance Free		
Number of Blocks	4 x 12V Batteries		
Number of Cells	360		
Float voltage	54Vdc		
Battery Cut Off voltage	40Vdc		
Charger Max (A)	15A	15A	45A
Battery Installation	Internal		
Battery Test Automatic	Standard every 6 days		
Battery Protection	Polarity Protection/ Short Circuit Protection / Fuses		

2.4 INVERTER SPECIFICATIONS

Model	EL1005XA	EL1012XA	EL1030XA
Nominal Output Voltage	230 VAC 1 phase + N		
Output Frequency	50 Hz		
Output Frequency Tolerance - Free Running - Line Synchronized	± 3 % ± 10 %		
Overload Capability	120% Load :Continuous 125-150% Load : 1 min >150% Load : By pass		
Harmonic Distortion	< 5 %		
Crest Factor	3/1		
Output Waveform	Sine Wave		
Short Circuit Protection	Electronic Short Circuit Protection		

2.5 BYPASS SPECIFICATIONS

Primary Components	Electronic Relay Switch
Nominal Voltage -V	230 VAC 1 phase + N
Nominal Frequency - Hz	50 Hz ± 5%
Retransfer : Changeover mode to Inverter	Automatic
Overload Capability	150 – 200 % Continuously
Manual By-Pass	Without Interruption

2.6 HEAT DISSIPATION (At nominal load and voltage)

Model	EL1005XA	EL1012XA	EL1030XA
Watts	100	250	600

2.7 MECHANICAL SPECIFICATIONS

Model	EL1005XA	EL1012XA	EL1030XA
Dimension (h x w x d)	850 x 750 x 250	1250 x 750 x 250	1250 x 750 x 400
Weight (W/O battery) (Kg)	35	40	50
Protection Level	IP20		
Colour	Blue		