

# KOHLER®

UNINTERRUPTIBLE  
POWER



## KOHLER *PW* 1000

Standalone tower or rack mount single-phase uninterruptible power supply with internal or external batteries

(1-3 kVA)

Technical Specification

## Document Control

ISSUE	DATE	REVISION SUMMARY
TS_700_01	13/09/2023	Rebranding to KUP International Version
TS_700_02	08/10/2024	Updated Dry Contact Card information

## Useful Contacts

### UK

<a href="http://www.kohler-ups.co.uk">www.kohler-ups.co.uk</a>	Kohler Uninterruptible Power web site
<a href="mailto:ukservice.ups@kohler.com">ukservice.ups@kohler.com</a>	Service department – booking service, fault reporting etc.
<a href="mailto:uktechnicalsupport.ups@kohler.com">uktechnicalsupport.ups@kohler.com</a>	Technical queries
<a href="mailto:uksales.ups@kohler.com">uksales.ups@kohler.com</a>	Hardware sales
<a href="mailto:ukservicesales.ups@kohler.com">ukservicesales.ups@kohler.com</a>	Extended warranty agreements etc

### IRELAND

<a href="http://www.kohler-ups.ie">www.kohler-ups.ie</a>	Kohler Uninterruptible Power web site
<a href="mailto:ieinfo.ups@kohler.com">ieinfo.ups@kohler.com</a>	Service department, technical queries, hardware sales and extended warranty agreements

### SINGAPORE

<a href="http://www.kohler-ups.sg">www.kohler-ups.sg</a>	Kohler Uninterruptible Power web site
<a href="mailto:salesups.sg@kohler.com">salesups.sg@kohler.com</a>	Hardware sales
<a href="mailto:serviceups.sg@kohler.com">serviceups.sg@kohler.com</a>	Contract customer support, maintenance contracts renewals

All product, product specifications and data are subject to change without notice to improve reliability, function, design or otherwise. Kohler Uninterruptible Power has taken every precaution to produce an accurate, complete and easy to understand specification document and will assume no responsibility nor liability for direct, indirect or accidental personal or material damage due to any misinterpretation of, or accidental errors, in this manual.

© 2024 Kohler Uninterruptible Power

This manual may not be copied or reproduced without written permission of Kohler Uninterruptible Power

## KOHLER PW 1000 (1-3KVA) UPS SYSTEM DESCRIPTION

By using the latest technological developments in power engineering, the KOHLER PW 1000 (1-3kVA) represents a new generation of transformerless UPS-System. Its advanced double conversion Voltage and Frequency Independent (VFI) topology responds fully to both the highest availability and environmentally friendly requirements, compliant with IEC 62040-3 (VFI-SS-111) standards.

### KOHLER PW 1000 (1-3KVA) UPS model range

The full PW UPS range comprises models rated from 1kVA to 10kVA. This specification applies to models in the lower range, rated at 1 kVA, 2 kVA and 3 kVA only, each of which is designed as a self-contained UPS comprising a rectifier, battery charger, inverter, static switch and battery pack. All the models in this range are easy to install, and supplied with suitably terminated power cables.

The PW1000 (1-3kVA) operates as a stand-alone UPS module and can be mechanically configured as a floor-standing tower unit or installed in a standard 19 inch rack. An accessory pack which contains all the parts necessary to configure the unit for either type of installation is supplied with the UPS.

Optional external battery cabinets are available to increase the UPS autonomy time. The battery cabinet design compliments the UPS cabinet and the two cabinets can be mechanically connected together to form a single unit when installed as a tower system. Up to three external battery cabinets can be connected in tandem as part of the UPS system.

### Advanced design features

The highlights of the KOHLER PW 1000 (1-3kVA) UPS system include its high reliability, low operating costs and excellent electrical performance.

Its key features include:

- True online technology continuously supplies your critical applications with stable, regulated, transient-free pure sine-wave AC power.
- High-Frequency Transformerless technology and tower-convertible enclosure enables the UPS to be integrated into even the most difficult environments with space constraints.
- User-friendly design that permits simple and trouble-free installation. All units are supplied with input and output power cables as standard.
- Smart battery management system which extends the battery life span.
- Highly efficient PWM sine-wave technology yields excellent UPS efficiency. The high crest factor of the inverter handles peak inrush current loads and so avoids a need to upgrade to a UPS with a higher power rating.
- Compliant with various stringent international EMC standards for electromagnetic interference & protection.
- Selection of output voltages (200/208/220/230/240) available to match the UPS to local supply specifications or specific load voltage requirements.
- A selectable bypass voltage tolerance (low/high sensitivity) restricts the range of voltages that can be applied to the load when the UPS operates on bypass. The ranges are  $\pm 15\%$  (low sensitivity) and  $\pm 10\%$  (high sensitivity). For example, if the output voltage setting is 230V the bypass sensitivity Low range is 230V  $\pm 15\%$ .
- Selectable 50Hz or 60 Hz operation.
- Fully digitized control logic for better functionality and enhanced power protection. Digital signal processing (DSP) also provides efficient communication capabilities for enhanced remote control and monitoring flexibility.
- Active power factor correction (PFC) control function constantly maintains the UPS input power factor to  $>0.99$  at 100% load, with resulting outstanding energy efficiency.
- Wide input voltage tolerance, from 110V~300V, allows the UPS to operate normally without draining the battery unnecessarily during significant mains voltage dips, which helps extend the battery service life.
- DC-start function permits the UPS to be started during a utility power failure if required.
- Overload protection system automatically switches the UPS to bypass mode if an overload occurs and automatically switch back to inverter mode once the overload condition ceases. Should the output become short-circuited, the UPS puts the system in stand-by mode, provides visible and audible alarms, and turns off the output supply automatically until the short circuit situation is resolved manually.

## GENERAL SPECIFICATION

### UPS Cabinet

Model Rating		1 kVA	2 kVA	3 kVA
Apparent output power	VA	1000	2000	3000
Real output power (@180-300VAC, PF=0.9)	W	900	1800	2700
Autonomy time (standard battery 100% load)	min.	5	5	4
Autonomy time (standard battery 50% load)	min.	14	15	12
Topology		Double conversion on-line VFI-SS-111		
Form factor		19"-Rack / Tower		
<b>Input:</b>				
Voltage	VAC	Single phase, 110 - 300 VAC (@60% load) Single phase, 150 - 300 VAC (@75% load) Single phase, 180 - 300 VAC (@100% load)		
Frequency	Hz	50 or 60 Hz, $\pm 6$ Hz		
Power factor		>0.99 at full rated linear load		
Input power connection		10A IEC 320-C14	10A IEC 320-C14	16A IEC 320-C20
<b>Output:</b>				
Voltage	VAC	Single phase, 230 VAC, selectable at 200/208/220/230/240 VAC 2 switched programmable outputs (setting via software)		
Switching time Inverter-Bypass (typical)	ms	4ms (typical)		
Voltage regulation	%	$\pm 1$ (until low battery warning)		
Frequency	Hz	50/60 Hz, $\pm 0.2\%$ Unless synchronised to line		
Synchronisation window	Hz	$\pm 3$ Hz or $\pm 1$ Hz (selectable)		
Voltage distortion (THD)	%	$\leq 3\%$ (linear load), $\leq 7\%$ (non linear load)		
Overload capability (AC Mode) (Tolerance $\pm 1\%$ )	%	<105% Load = continuous operation, from 106%...120% Load = transfer to bypass after 30 Sec. from 121%...150% Load = transfer to bypass after 10 Sec >150% Load = transfer to bypass immediately Buzzer continuously alarms		
Overload capability (BATTERY Mode) (Tolerance $\pm 1\%$ )	%	Up to 105% Load = continuous operation, from 106%...120% Load = shut down after 30 Sec. from 121%...150% Load = shut down after 10 Sec >150% Load = shut down immediately Buzzer continuously alarms		
Overload capability (BYPASS Mode) (Tolerance $\pm 1\%$ )	%	Up to 105% Load = continuous operation, from 106%...120% Load = shut down after 250 Sec. from 121%...130% Load = shut down after 125 Sec. from 131%...135% Load = shut down after 50 Sec. from 136%...145% Load = shut down after 20 Sec. from 146%...148% Load = shut down after 5 Sec. from 149%...157% Load = shut down after 2 Sec. from 158%...176% Load = shut down after 1 Sec. from 177%...187% Load = shut down after 0.32 Sec. >188% Load = shut down after 0.16 Sec. Buzzer continuously alarms		
Short circuit handling		In normal mode: output breaker / electronic circuit In battery mode: output breaker / electronic circuit In bypass mode: input fuse		
Over-temperature (AC Mode)		Switch to bypass		
Over-temperature (On Battery Mode)		Immediate UPS shutdown		
Crest factor		3:1		

Model Rating		1 kVA	2 kVA	3 kVA
Heat dissipation (approx)	W	150	275	415
Output power connection		(3) 10A IEC 320-C13	(6) 10A IEC 320-C13	(6) 10A IEC 320-C13 (1) 16A IEC 320-C19
<b>Efficiency:</b>				
Mains operation (Full linear load @230V)	%	Up to 92	Up to 92	Up to 92
Battery mode (Full linear load)	%	86	87	87
ECO (bypass) mode (Full linear load @230V)	%	97	97	97
<b>Environment:</b>				
Temperature (°C)	°C	Operating: 0°C~40°C / Storage: -10°C~50°C The battery temperature must be maintained at 20°C to ensure its lifespan is not reduced)		
Altitude	m	0-2000m up to 40°C / 3000m up to 35°C		
Humidity	%	0%...90%, non-condensing		
Sound level	dBA	<50 dBA		
<b>Batteries:</b>				
Quantity (internal)		3	6	6
Type VRLA		12V / 7.2Ah	12V / 7.2Ah	12V / 9.0Ah
Rated battery voltage	VDC	36	72	72
Battery back-up time (@50%,100% load)	Mins	14, 5	15, 5	12, 4
Charge current (Standard / Extended charger)	A	2.1A, 3.1A	1.5A, 3.1A	1.5A, 3.1A
Recharge time to 90%	Hrs	4 - 6 Hrs	4 - 6 Hrs	4- 6 Hrs
Float charging voltage	VDC	40.95 ±1%	81.9 ±1%	81.9 ±1%
Bulk charging voltage	VDC	42.3 ±1%	84.6 ±1%	84.6 ±1%
Discharging current (with UPS and Mains OFF)	uA	< 30uA		
Life cycle (typical)		Up to 5 years, at Max. 20°C temperature		
<b>Communications</b>				
Standard interfaces		EPO, RS-232		
Optional interfaces		2nd RS-232, USB, CS141 SNMP card, Dry contact relay card		
Compatible platforms		Windows, Linux, Mac etc		
<b>Mechanical Data:</b>				
Dimensions (WxHxD)	mm	440 x 88(2U) x 405	440 x 88(2U) x 600	440 x 88(2U) x 600
Weight (With internal Battery)	kg	18 kg	34.4 kg	39.6 kg
Input power connection		10A IEC 320-C14	10A IEC 320-C14	16A IEC 320-C20
Output power connection		(3) 10A IEC 320-C13	(6) 10A IEC 320-C13	(6) 10A IEC 320-C13 (1) 16A IEC 320-C19
Other connectors		1 x USB, 1 x RS232, 1 x 2-pole EPO/ROO Connector 1 x Interface Slot		
<b>Options:</b>				
Accessories		External bypass External battery module(s) Output distribution 19"- rack rails (up to 1 Meter)		
<b>Compatibility:</b>				
Operating systems		Windows, Unix (and derivatives), OS/2, Novell, AppleOS		
<b>Audible Alarms:</b>				
Battery mode		Will sound every 1.5 Seconds		

Model Rating		1 kVA	2 kVA	3 kVA
Battery low		Resounds every 2.0 Seconds		
Overload		Resounds every 3.0 Seconds		
General error		Will sound permanently (or every 3 Seconds)		
<b>Standards:</b>				
Safety		IEC/EN 62040-1-1		
EMC-Compatibility		EN 62040-2, EN 61000-3-2, EN61000-3-3,		
Performance features		IEC/EN 62040-3		
Product certification		CE, UKCA		
Protection Class		IP 20		
Manufacturing standards		ISO 9001		

### External battery cabinet

Model Rating		230V - 1 kVA	230V - 2 kVA / 3 kVA
Battery voltage	VDC	36	72
Battery number & capacity	Ah	6x 12V/ 7Ah-9Ah	12x 12V/ 7Ah-9Ah
Battery strings		2x Strings of 3 batteries	2x Strings of 6 batteries
Dimensions (WxHxD) mm	mm	440 x 88(2U) x 405	440 x 88(2U) x 600
Weight (Empty)	kg	4.7 kg	4.9 kg
Weight (with 9Ah Batteries)	kg	17.3 kg	30.1 kg
Output current (Max)	A	50	50
Operating environment		0~40°C / 32~104° (The battery temperature must be maintained at 20°C to ensure lifespan is not reduced) 30-90%RH non-condensing	
Storage environment		-15~45°C / 5~113°F 30-90%RH non-condensing	
Compliance		CE, UKCA	

## UPS CONTROL PANEL

The front-mounted UPS Control Panel is easy to operate and comprises three areas:

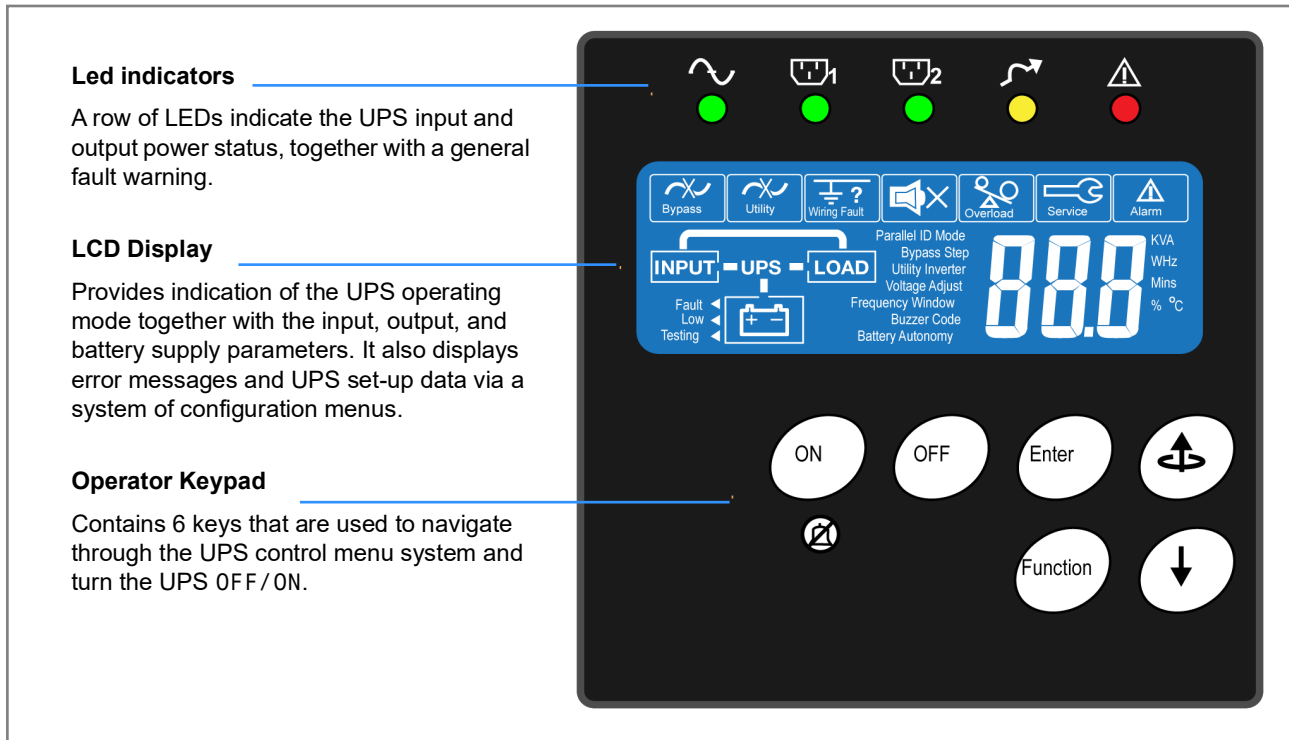

### Led indicators

A row of LEDs indicate the UPS input and output power status, together with a general fault warning.

### LCD Display

Provides indication of the UPS operating mode together with the input, output, and battery supply parameters. It also displays error messages and UPS set-up data via a system of configuration menus.

### Operator Keypad

Contains 6 keys that are used to navigate through the UPS control menu system and turn the UPS OFF / ON.

## LED Indicators



### Input mains supply status



This led is permanently ON if the mains supply is within in the normal operating range of 160~300 VAC, and flashes if the supply falls to 120~159 VAC. If the led is OFF it indicates a mains supply failure.



### Programmable outlet status



The programmable outlets are normally connected to less critical loads which can be shed when the utility power fails. This reduces the load on the battery as it discharges and thereby increases the back-up time for the more critical loads which are connected to the unswitched UPS outlet(s). The indicators are permanently ON when the outlets are live.



### Bypass supply status



This led is permanently ON when the UPS is operating in the ECO mode and flashes when the load is transferred to bypass – either manually or due to a detected fault.



### UPS fault indication



This LED illuminates to indicate the presence of a fault condition within the UPS that needs attention. It is usually accompanied by an audible alarm.

### LCD Display

The LCD display contains a row of warning symbols, a mimic diagram which indicates the power path through the UPS, a battery status indicator and a multi-function 3-digit numerical display which can be selected to indicate a range of operating parameters. Each of these areas are described below.

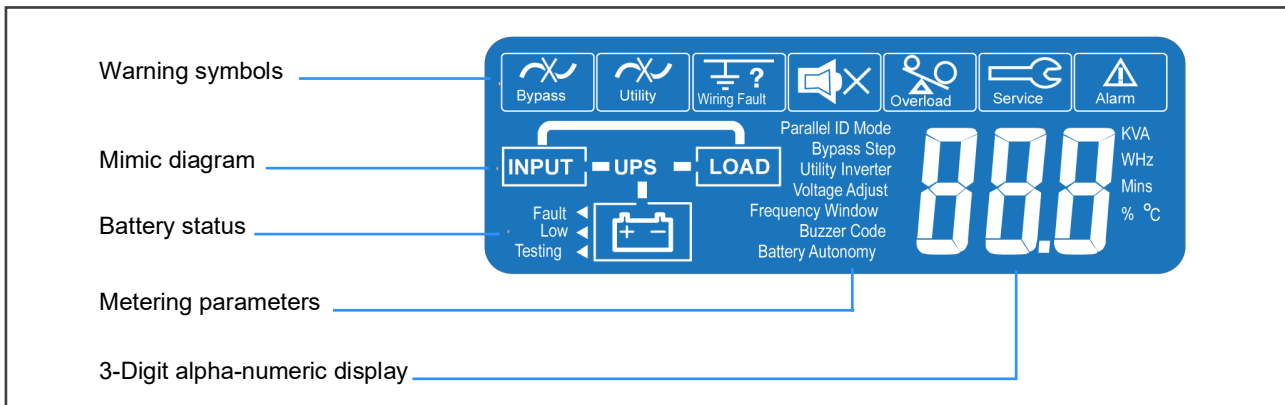

### Warning symbols



**Bypass input abnormal:**  
UPS fails to transfer to bypass, bypass abnormal in ECO mode



**Utility input abnormal:**  
The utility mains supply is outside the UPS pre-set operating window



**Wiring fault:**  
Site wiring problem such as reversed Line-Neutral connection



**Alarm buzzer silent**  
The alarm buzzer has been silenced or disabled



**Overload:**  
The UPS output is overloaded



**Service:**  
The UPS is operating in its service mode



**Alarm:**  
An alarm condition is present. This remains active after the audible alarm is reset if the alarm still exists.

### Meter Display

When the UPS is turned on, you can scroll through the measurement display screens using the UP and DOWN keys on the operator keypad. The parameter display sequence is as numbered in the table below and loops around in either direction.

1 Utility Voltage (V)	4 Inverter Frequency (Hz)	7 Battery Voltage (V)
2 Utility Frequency (Hz)	5 Inverter Load %	8 Battery Autonomy (mins.)
3 Inverter voltage (V)	6 Inverter Load (A)	9 UPS Temperature (°C)



## COMMUNICATION OPTIONS

The UPS has several provisions for communicating with external devices and systems, including:

- External Emergency Power Off (EPO).
- RS-232 and USB ports to provide communication with monitoring software installed on a remote PC.
- Optional card slot that can be used with:
  - an intelligent CS141 card for local or area network UPS monitoring and control OR
  - a Dry Contact relay card to provide volt-free signalling that can be integrated into an external alarm monitoring or building management system.

All communication ports, including the optional cards, can be active and used simultaneously to monitor the UPS status; however, only one communication interface at a time can control the UPS. This is determined on a priority basis, with the higher priority interface gaining control.

The interface control priorities are as follows:

- EPO input port
- Optional interface card
- Optional USB
- Optional RS-232

### Emergency Power Off (EPO)

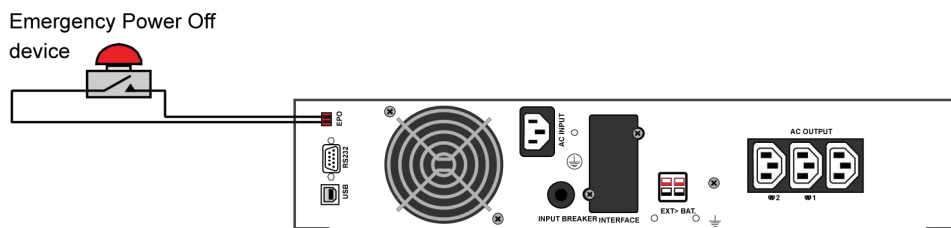

The Emergency Power Off (EPO) option allows you to turn off the UPS using an external switch or contact that is wired to the EPO terminal block on the back of the UPS. The external circuit consists of a 'normally open' external contact that will power-off the UPS when the contact is closed. The connection should be made using a screened, single pair cable (0.5mm<sup>2</sup>) with a maximum length of 100 metres.

When the EPO circuit is activated the UPS output will turn off, removing power to the load, but the battery charger will remain operational to maintain battery charging. An EPO alarm is shown on the LCD display but you can still scroll through and monitor the UPS input, battery and output metering.

### RS-232 Computer serial interface

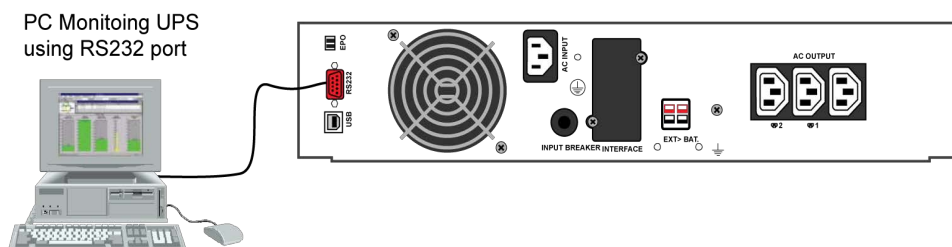

*Note: The USB port is connected in parallel with RS-232 port and outputs the same data stream.*

When used in conjunction with suitable software, the RS-232 and USB ports allow the connected PC to continuously monitor the input mains voltage and UPS status, and display appropriate operating data and messages.

The RS-232 connector is a 9-pin female D-type and can be connected to a PC using standard serial cable. The maximum permitted RS-232 cable length is 15 metres.

**CS141 /SNMP adapters**

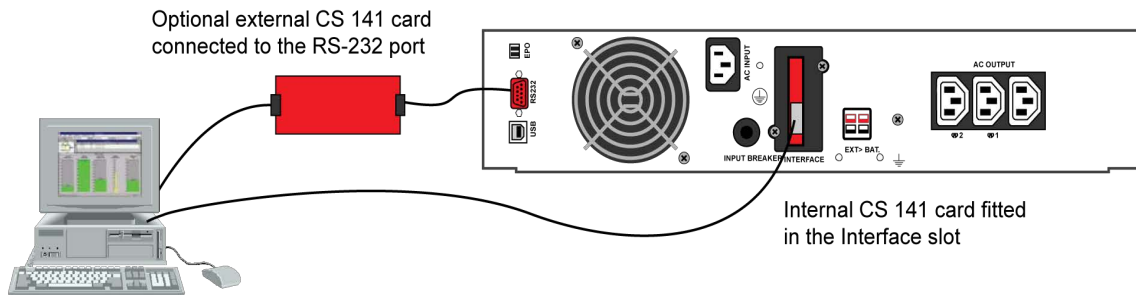

Simple Network Management Protocol (SNMP) is a world-wide, standardised communication protocol that can be used to monitor any network-connected device via a simple control language and display the results in a browser-based application. The software agent built in to the CS141 adapter card makes the UPS data available in this SNMP format which can then be utilized by a number of UPS management software applications.

The card contains a serial interface, which can be connected directly to a computer’s serial port, and an RJ-45 connector which allows it to be connected to a network using a standard CAT-5 cable. The SNMP adapter can be configured via Telnet, http (browser) or serial connection. For normal operation, at least one Ethernet network connection is necessary.

Once installed, the UPS-Management software agent, which is already installed in the card, monitors the UPS operation and outputs its data in SNMP format to the connected network. The card enables automated generation of event/alarm emails, server controlled shut down (with optional licenses) and other tasks, and can also be integrated with BMS software over a local area network (LAN) for SNMP or Modbus information over IP. Kohler Uninterruptible Power offer monitoring software with SNMP functionality for Novell, OS/2, and Windows that run both on INTEL and on ALPHA, DEC VMS and Apple.

An optional external SNMP adapter can be connected to the UPS via its RS232 port if the UPS card slot is in use (e.g. DCE card fitted) but SNMP facilities are still required.

**RCCMD**

RCCMD (Remote Console Command Module) for ‘multi-server shut down’ is an independent software module intended for transmitting and receiving ‘remote commands’. Using the ‘RCCMD send’ function, the SNMP adapter can send status messages to connected users or initiate automatic shut down throughout the whole network. Our CS141 SNMP adapters are fully compatible with RCCMD.

**Dry Contact card**

DCE-C is an UPS management product with 6 relay output contacts for monitoring the status and 3 input contacts as a shutdown UPS command. The volt-free signalling outputs can be integrated into an external alarm monitoring panel or building management system.

All the output connections for R1 to R6 are switched by independent relays and can be configured either N/C or N/O. Details for configuration are provided in the documentation that accompanies the card.

Relay terminals are rated up to 40VDC,800mA.

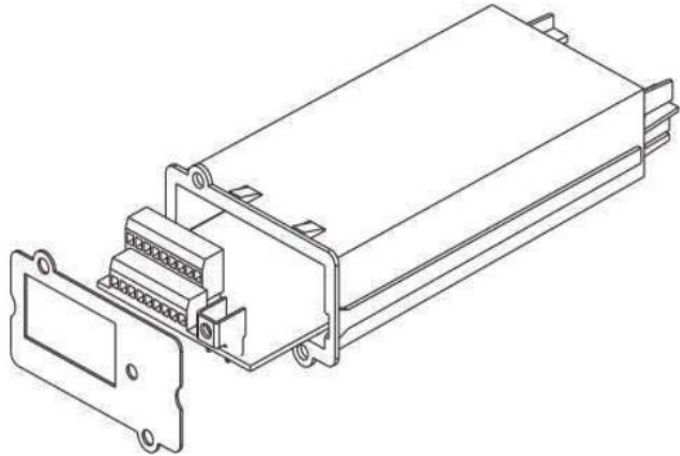

Dry Contact card (DCE)

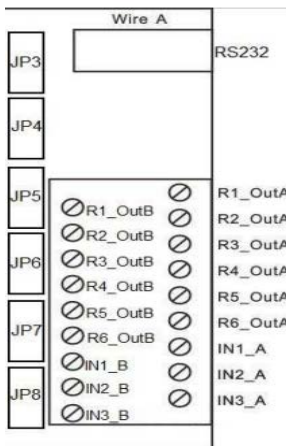

Pin outs

The pin outs are shown on the left and function as table below.

Pin	Function
R1_OutB/R1_OutA	UPS on Bypass Mode
R2_OutB/R2_OutA	Utility Abnormal/Utility Normal
R3_OutB/R3_OutA	Inverter On
R4_OutB/R4_OutA	Battery On
R5_OutB/R5_OutA	Battery Bad or Abnormal
R6_OutB/R6_OutA	UPS Alarm
IN1_A/IN1_B	Remote Shutdown by Utility status
IN2_A/IN2_B	Energy saving shutdown by Utility status and load percentage
IN3_A/IN3_B	Energy saving shutdown by Utility failure time
RS232	Communicate to PC for setting or firmware upgrade

## INSTALLATION PLANNING

The following *guidelines* should be taken into account when planning a suitable location and environment for the KOHLER PW 1000 (1-3kVA) UPS installation.

### Choosing a suitable installation location

#### Environment considerations summary:

- Avoid high ambient temperature, moisture and humidity:
  - temperature should be between 0°~40°C.
  - the battery temperature must be maintained at 20°C to ensure its lifespan is not reduced
  - humidity should be less than 90% non-condensing
- An adequate cooling air flow must be available if necessary to sustain a suitable temperature
- Ensure no dust or corrosive/explosive gasses are present.

#### Location considerations summary:

- The UPS is not designed for outdoor use
- The installation location must be vibration free, clean, dry and free of excessive dust
- If the UPS system is installed as a Tower system, the supporting surface should be non-flammable
- The UPS must not be installed in a corrosive environment or in the vicinity of flammable items
- Local fire protection standards must be respected
- The ventilation grills at the front of the UPS and extractor fans at the rear of the UPS must not be obstructed at any time
- The UPS power supplies must be readily available
- The UPS equipment must be installed with the clearances illustrated below. If it is to be installed as a Tower system the connected cables must be of an adequate length to allow the UPS to be manoeuvred for maintenance access if necessary, as shown.

**Clearances**

**Tower installation**

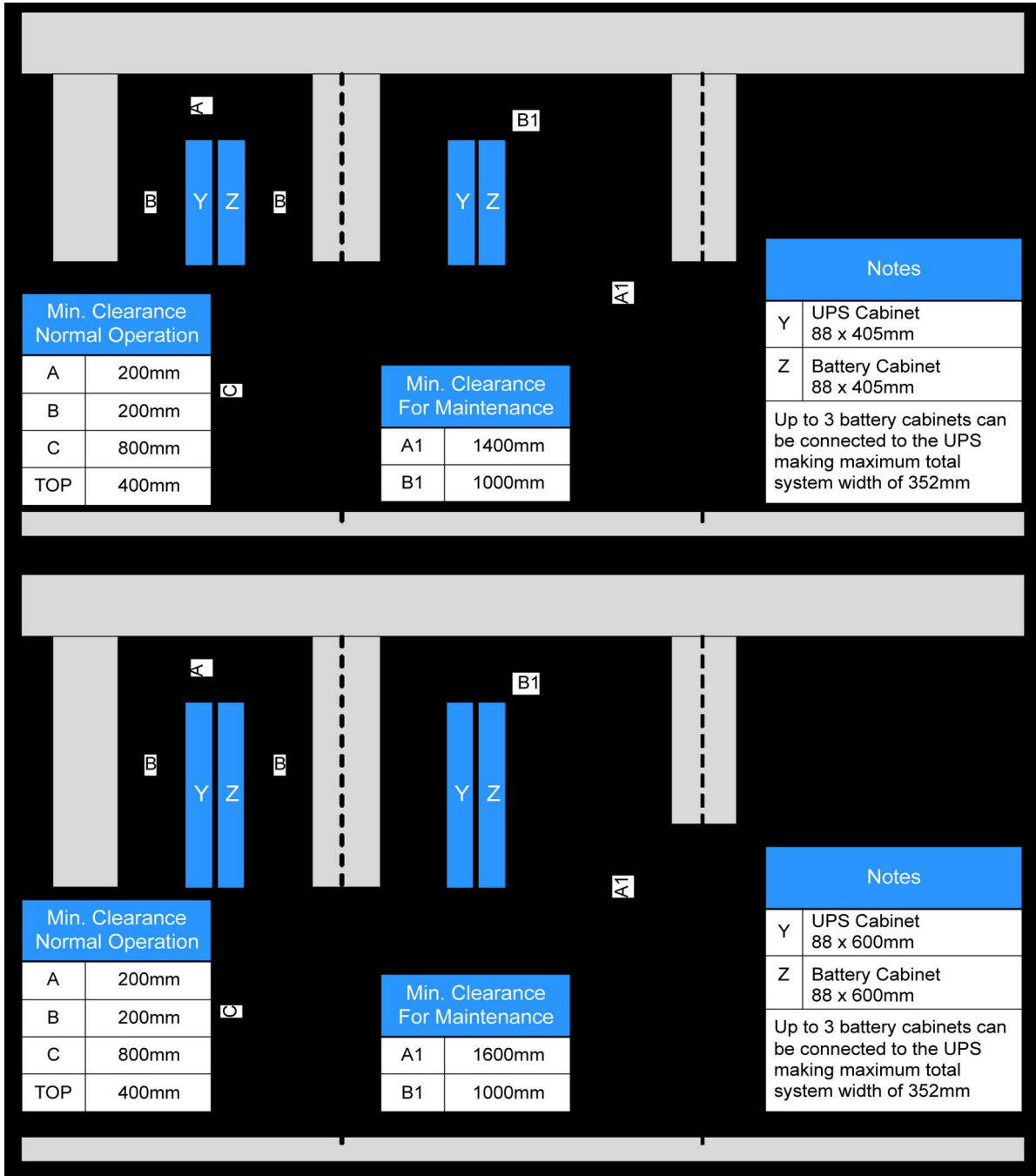

The total width of the system hardware can range from 88mm, for a stand-alone UPS cabinet, up to 352mm where the maximum of three (optional) battery cabinets are attached to the UPS cabinet – only one battery cabinet shown in the diagram above.

The left hand diagrams show the ‘operating’ clearances necessary to provide adequate cooling. For maintenance, at least 800mm side access is required and, where necessary, the cables connected to the UPS should be made sufficiently long to allow the UPS to manoeuvred to a position where the clearances shown in the right hand diagrams are obtainable.

## Rack mounting

When the UPS is rack-mounted, a minimum of 200mm should be available between the rear of the UPS and the back of the rack cabinet to enable adequate ventilation and provide space for cabling. It is permissible to install the PW1000 1kVA model in a cabinet with a depth of 600mm, although this will only provide 195mm rear clearance rather than the desired 200mm shown in the above diagram.

The rack cabinet must have a ventilated door and a minimum clearance of 800mm must be provided at the front and rear of the cabinet to allow full UPS access for installation and maintenance.